

Study on Mach Reflection and Mach Configuration

CHEN Shuxing

Hyp-2008, Maryland

Outline

- Physical phenomena
- Some crucial issues
 - Stability of Mach configuration
 - von Neumann paradox
 - Other irregular configurations
 - Global wave pattern
- A result on global existence of stationary Mach reflection
- Summarize open problems

Part I: Physical phenomena

Unsteady Case
(a shock front hits ground)

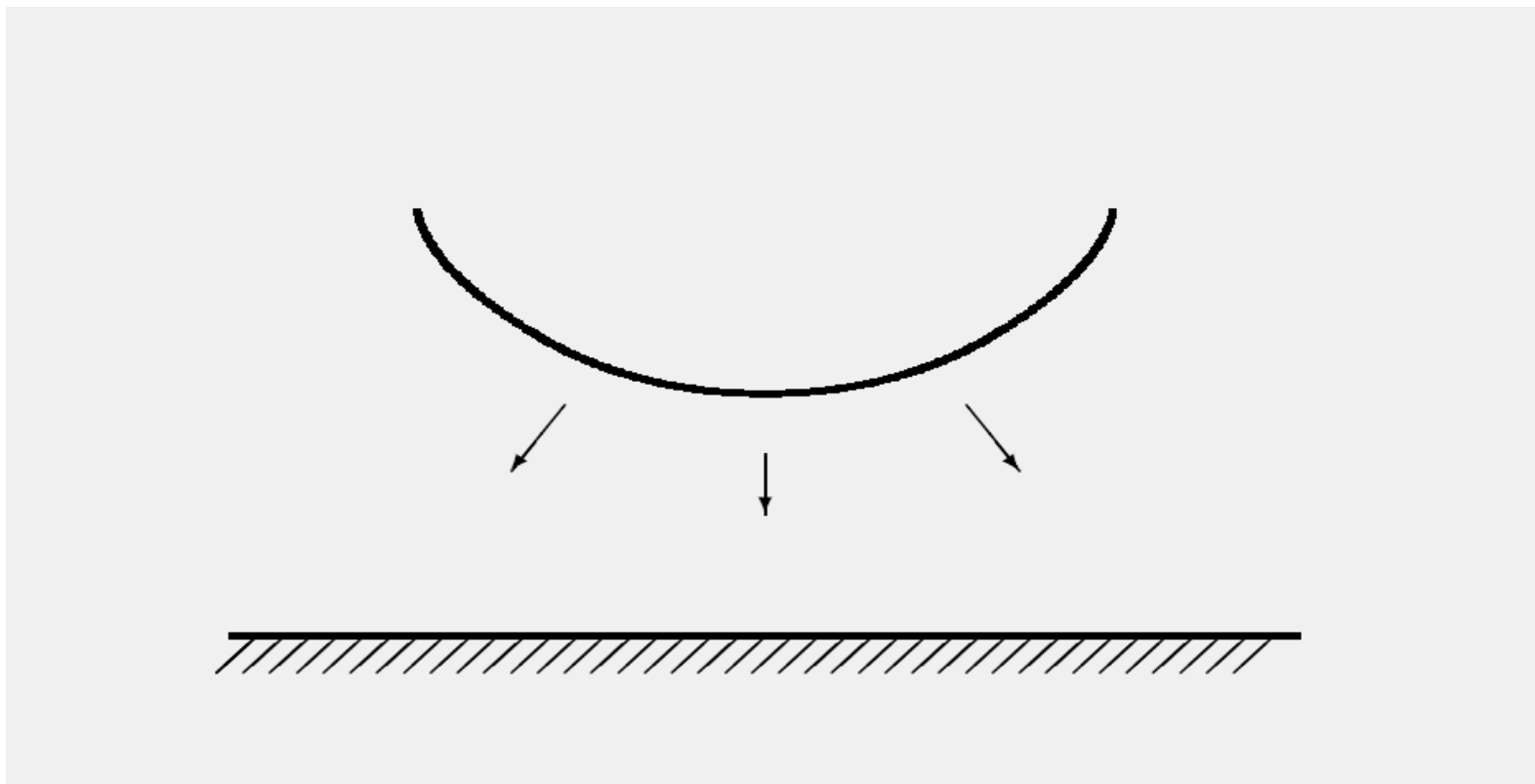

Two cases of shock reflection

Regular reflection

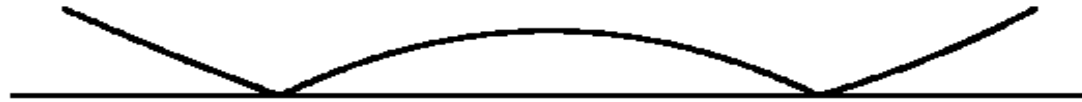

Mach reflection

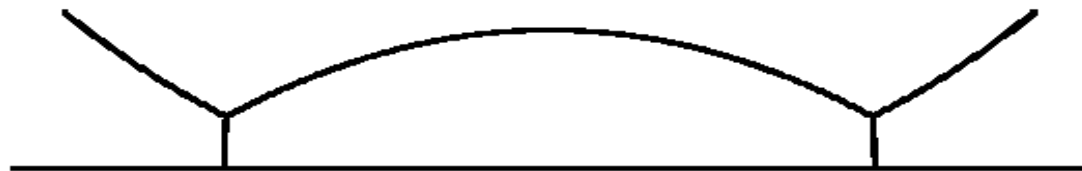

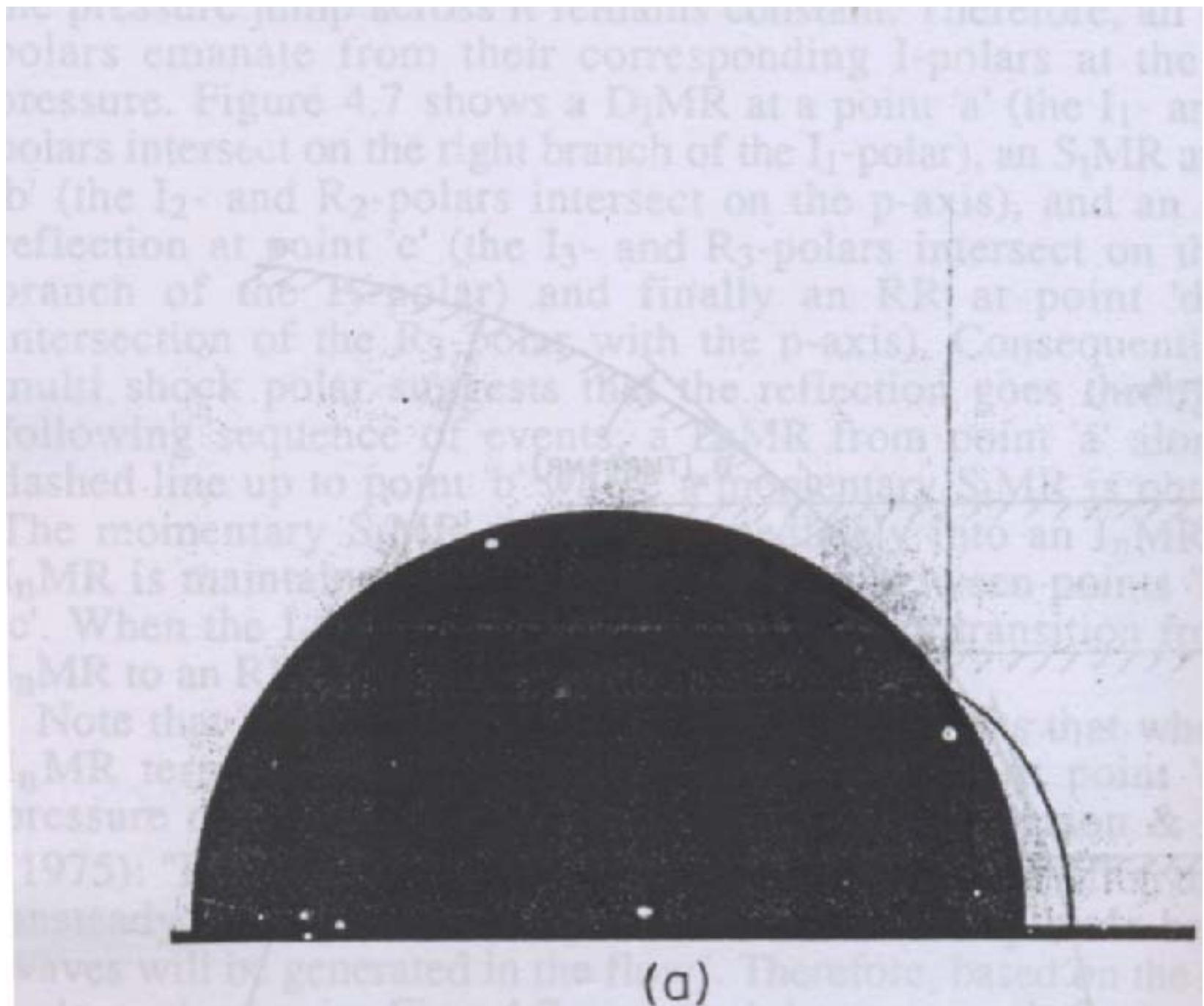

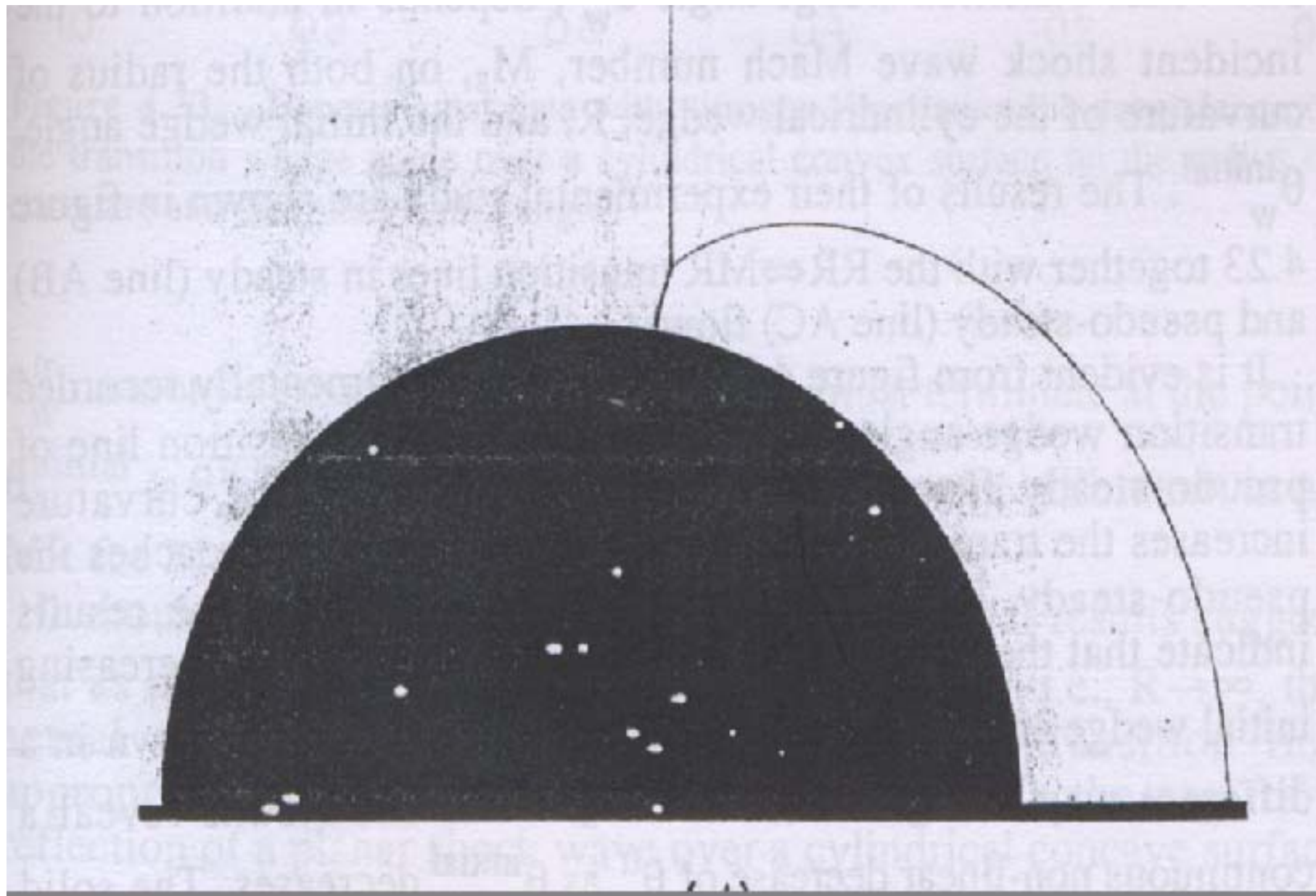

Pseudo-steady case

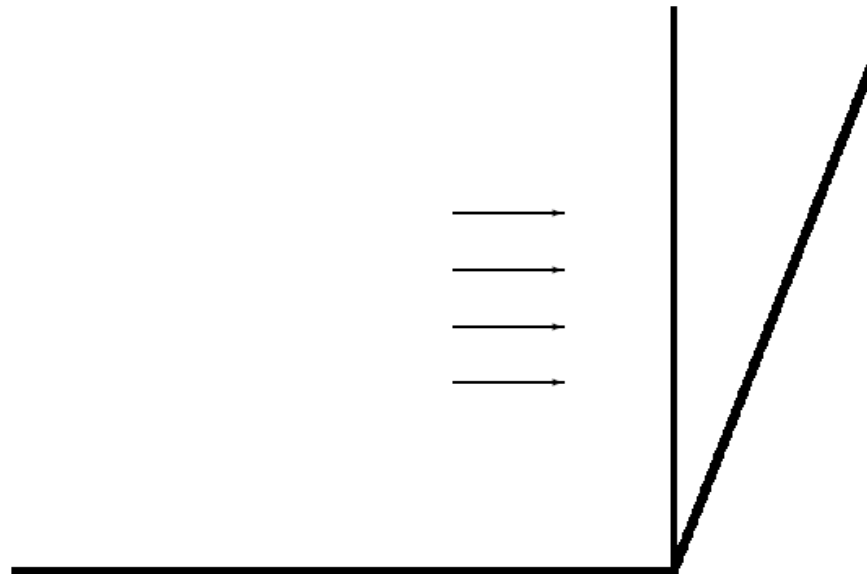

Shock front hitting a ramp

Invariance under transformation: $t \rightarrow \alpha t, x \rightarrow \alpha x, y \rightarrow \alpha y$

Self-similar solution: $U(t, x, y) = U(x/t, y/t)$

Regular reflection

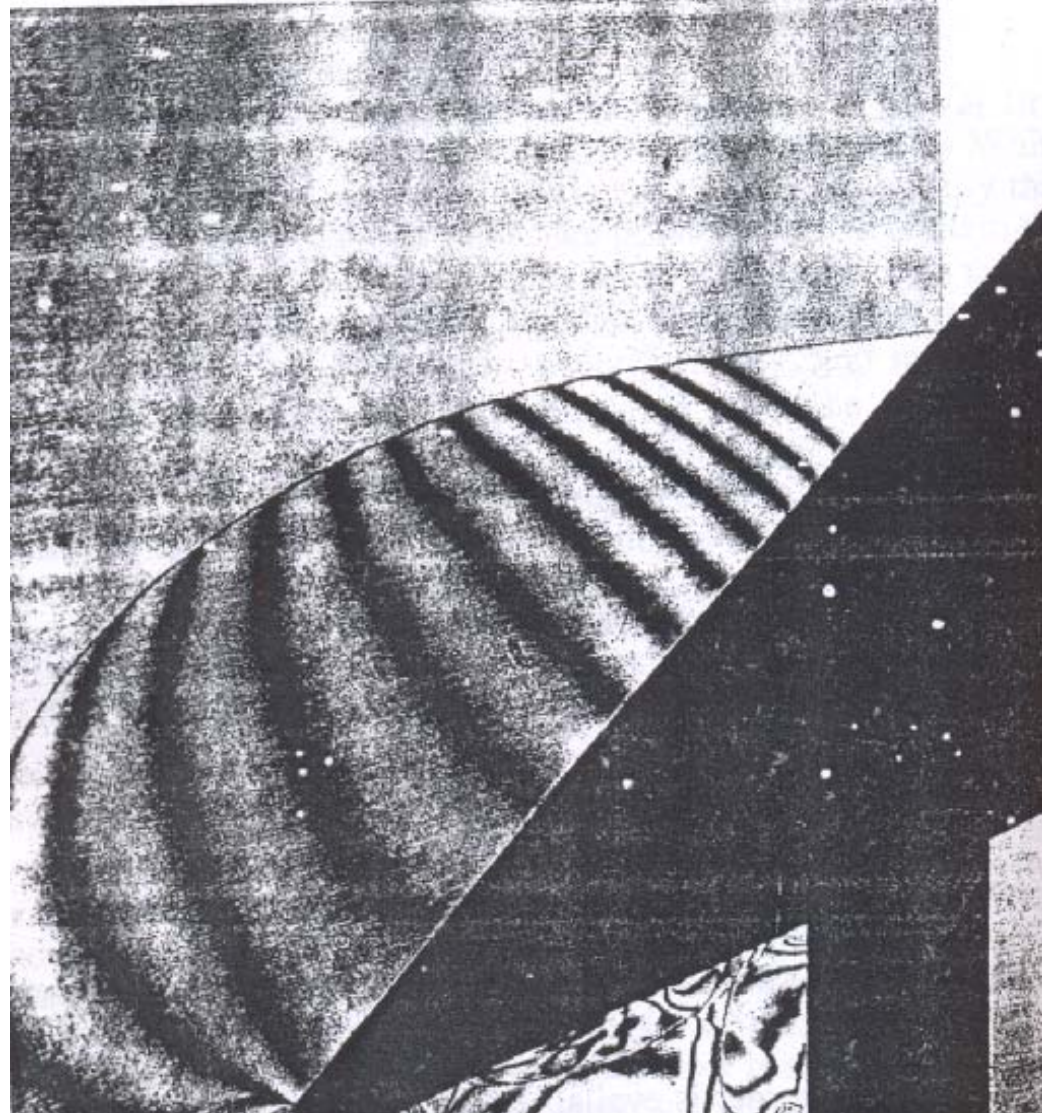

Regular reflection

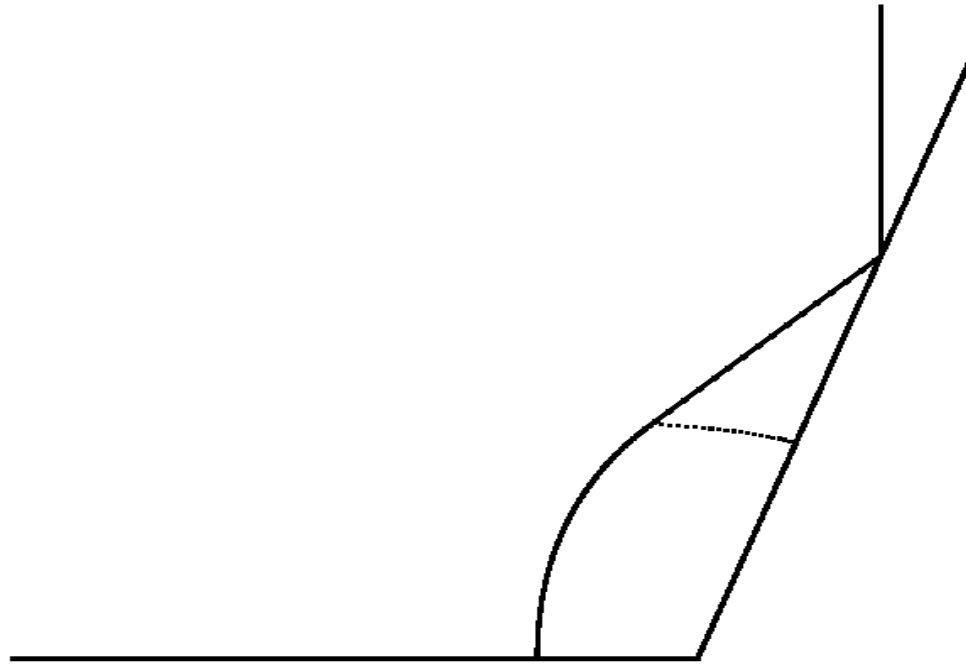

S.Canic, B.L.Keyfitz, E.H.Kim, : Unsteady Transonic Small Disturbance Eq.
Nonlinear wave equation

Y.X.Zheng: Gradient Pressure Equation

G.Q.Chen & M.Feldman: Potential Equation

T.P.Liu & V.Elling: Potential Equation

Mach reflection

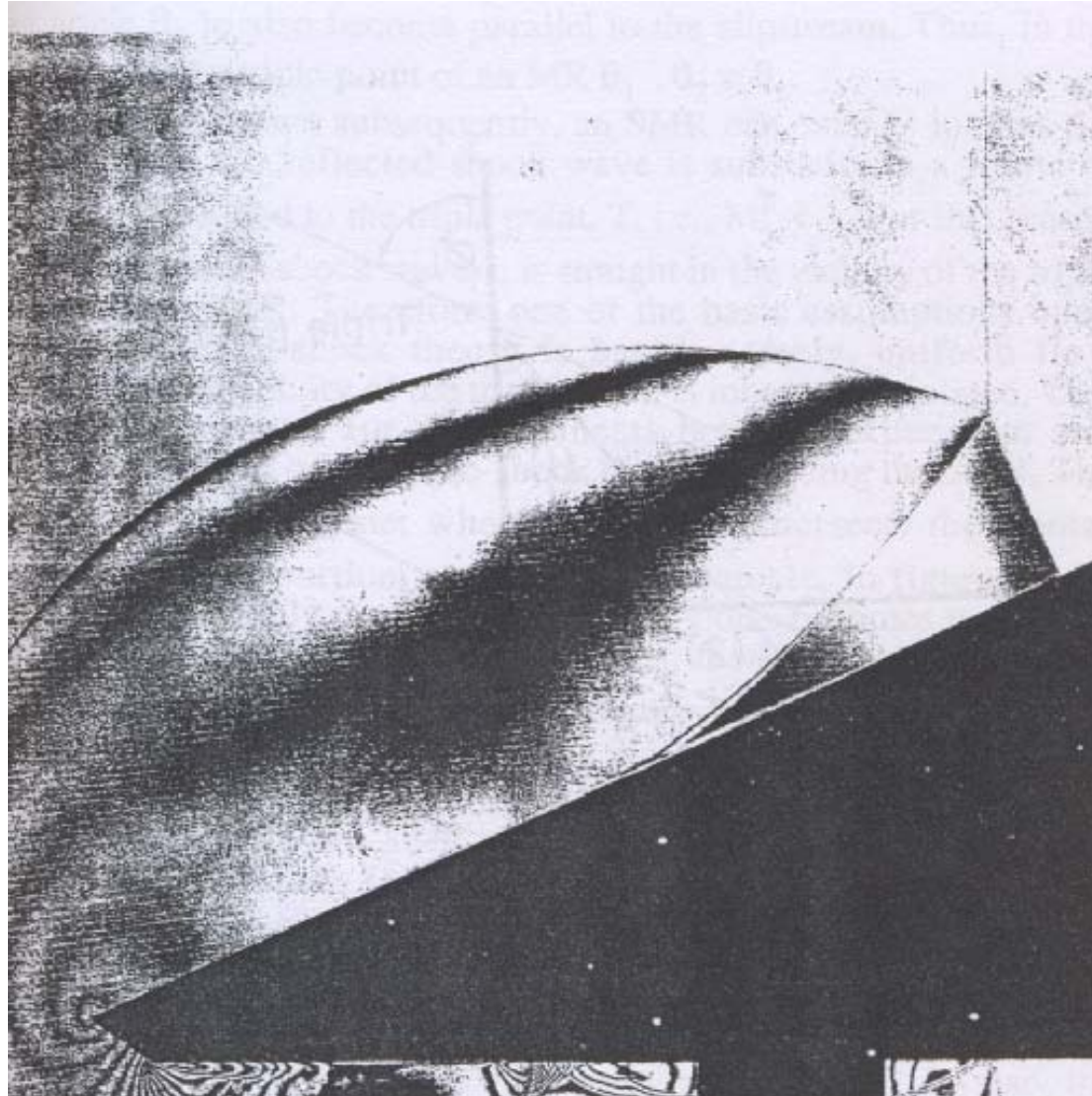

Mach reflection

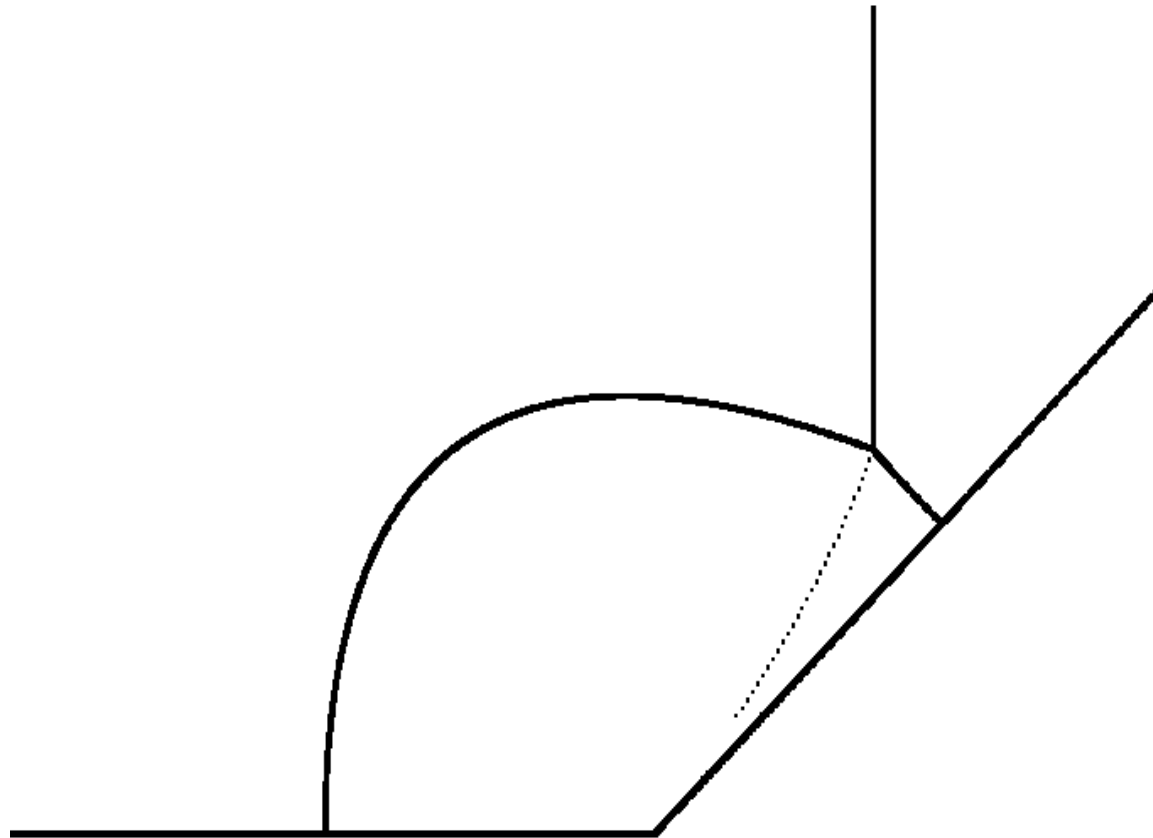

Steady case (Mach reflection)

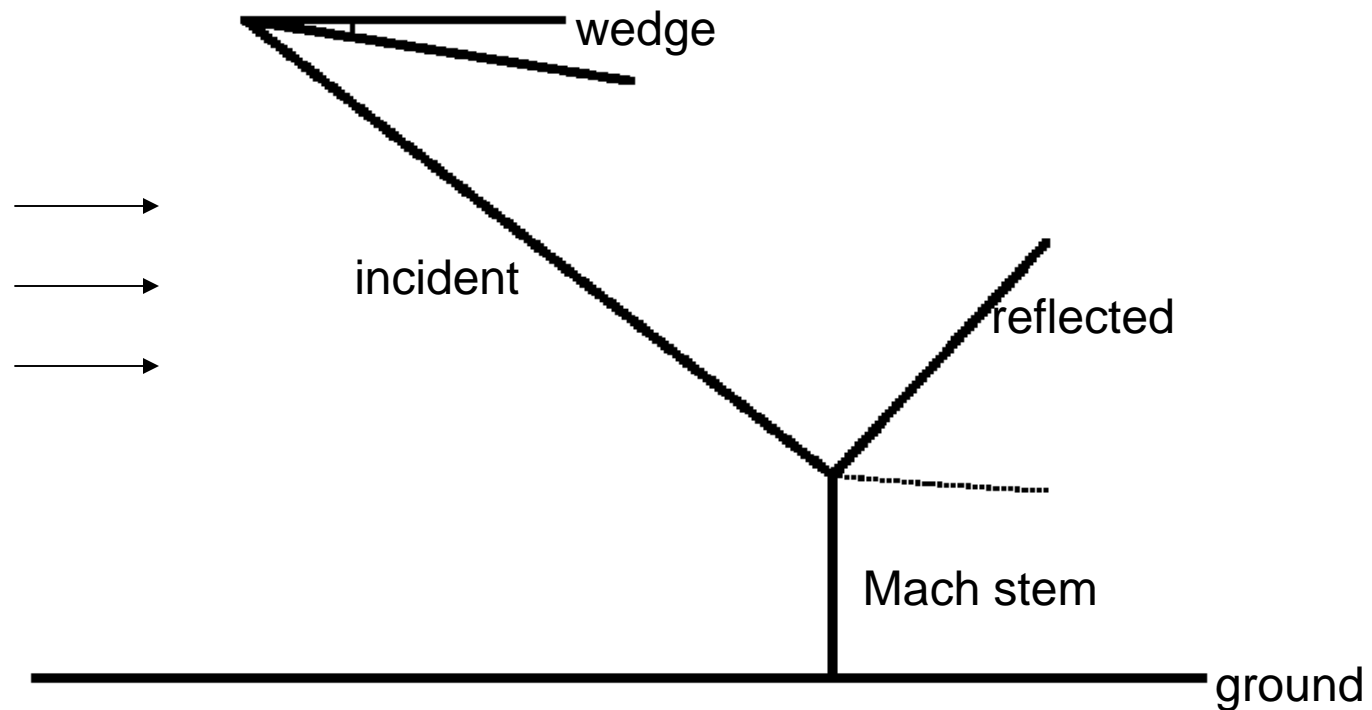

Similar wave pattern occurs for the compressible flow in a duct

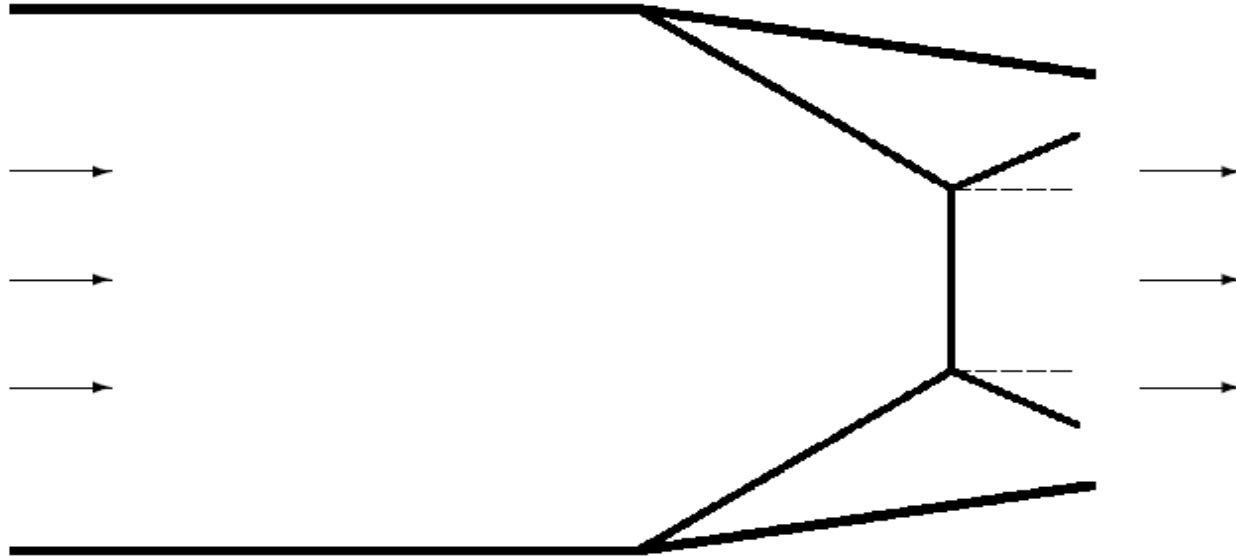

Part II: Some crucial issues

Problem : What is the right wave configuration near the triple intersection point ?

Three shocks separating
three zones of different
continuous states are
impossible !

R.Courant & K.O.Friedrichs

C.Morawetz

D.Serre

von Neumann suggestion: Mach configuration

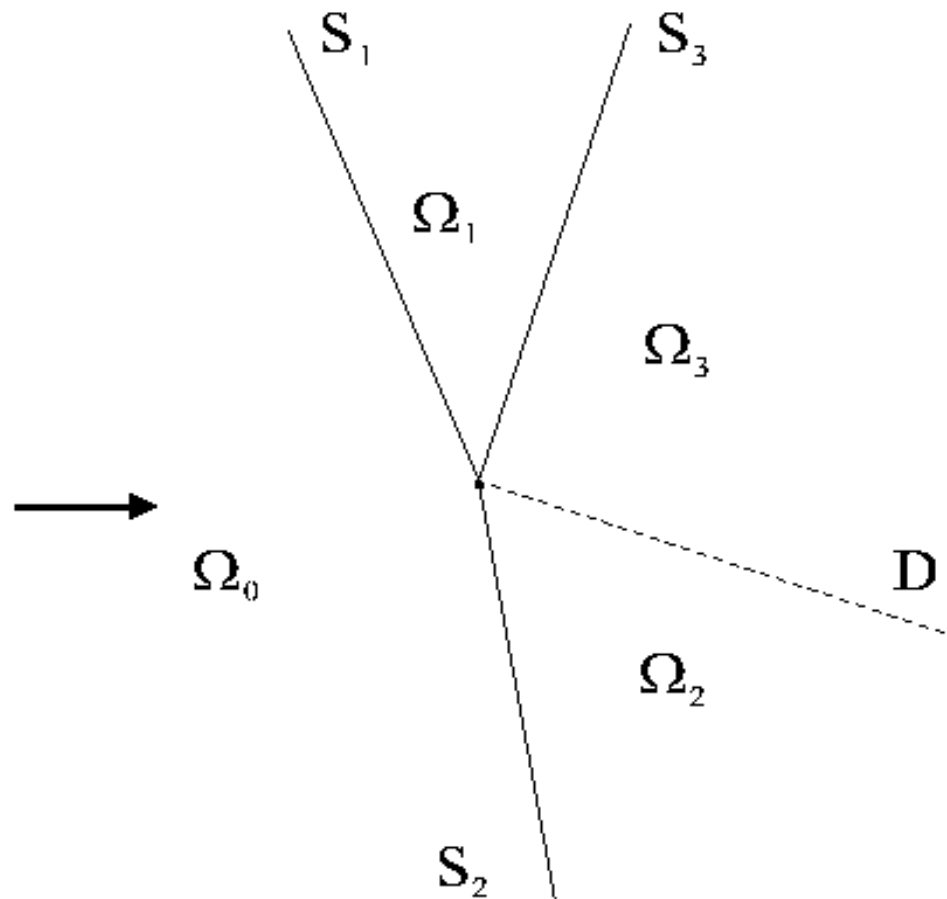

The flat configuration can be obtained by using shock polar

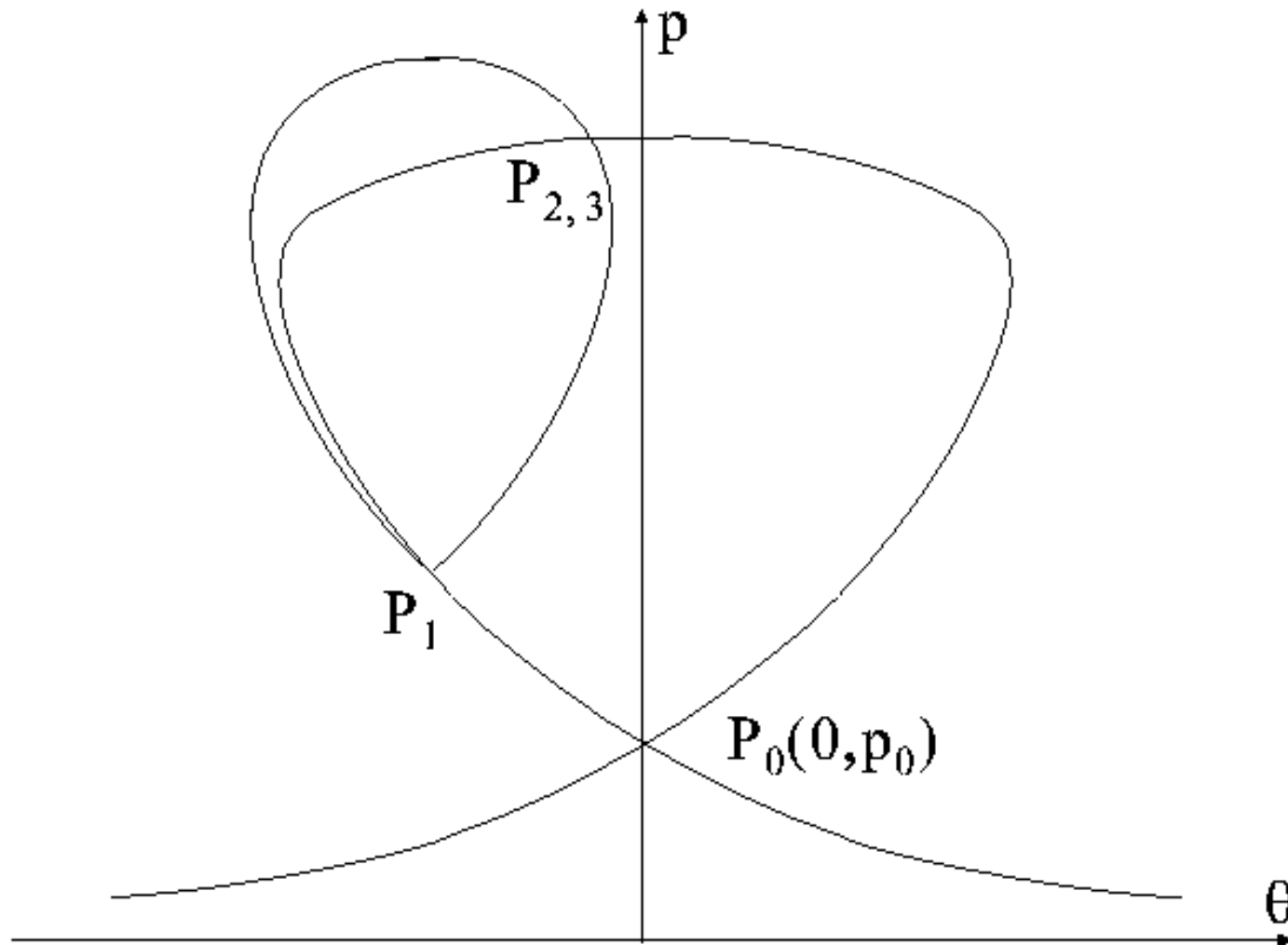

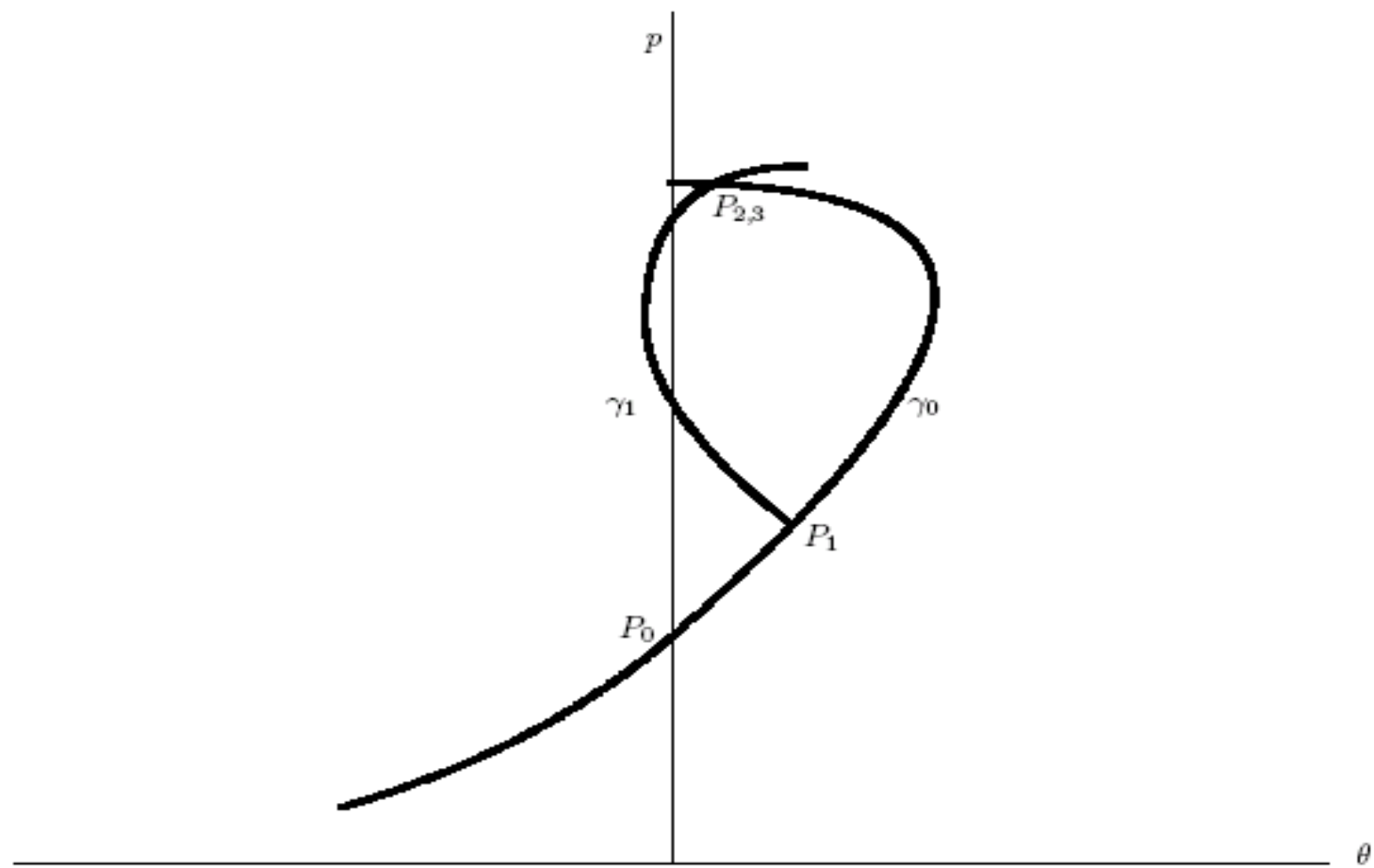

(θ, p) shock polar (E-E type)

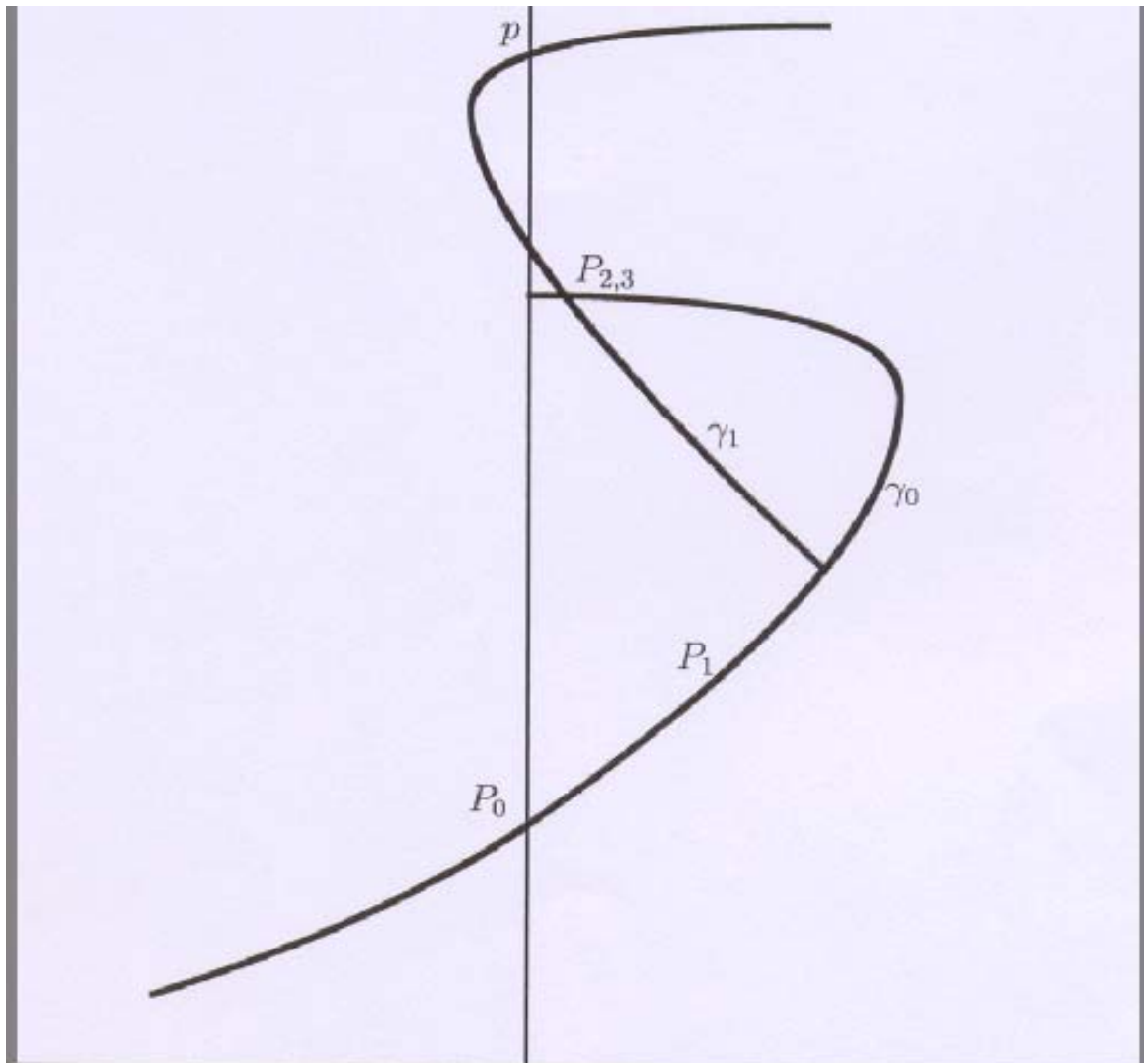

(θ, p) shock polar (E-H type)

Confirm the stability of Mach configuration under perturbation

- Shuxing Chen: Stability of a Mach Configuration, Comm. Pure Appl. Math. v.56(2006).
- Shuxing Chen: Mach Configuration in pseudo-stationary compressible flow, Journal AMS, v.21(2008).

Conclusion

When the supersonic part of a given flat Mach configuration (E-E type) is slightly perturbed, then

1. whole structure of the configuration still holds.

2. all elements of the subsonic part are also slightly perturbed.

E-H type Mach configuration will lead us to study on nonlinear mixed type equation of Lavrentiev type:

An (nonlinear) equation is hyperbolic type in a part of the domain, and is elliptic type in other part of the domain. The coefficients have discontinuity on the line, where the equation changes its type. The line and a part of the boundary are determined together with the solution.

Problem on transition

Regular reflection for small β_i
(wave angle of the incident)

Mach reflection for large β_i

How does a regular reflection
transit to a Mach reflection?

Dual-solution Domain

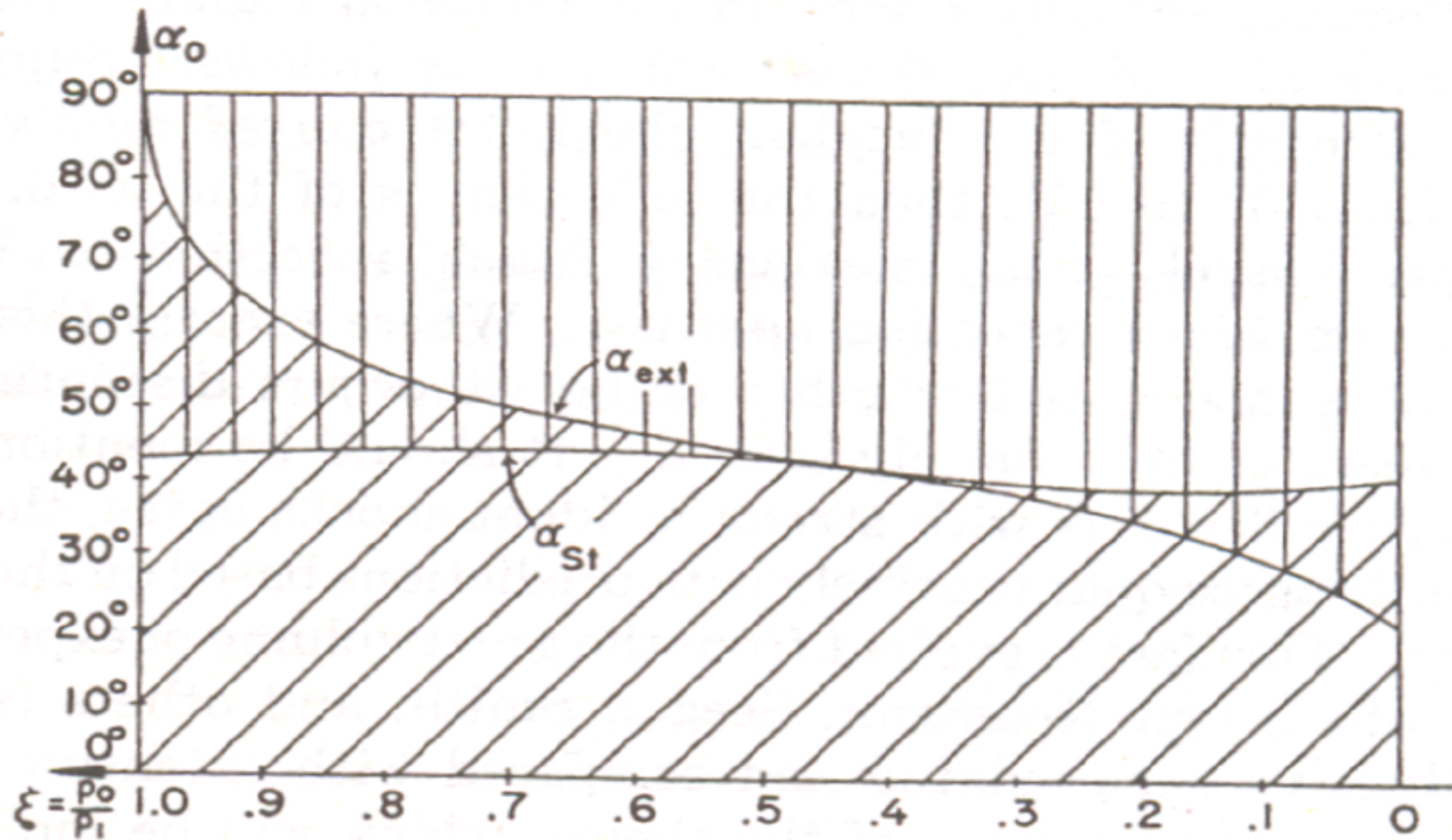

Upper part: Mach reflection

Lower part: Regular reflection

Overlapped: Dual-solution domain

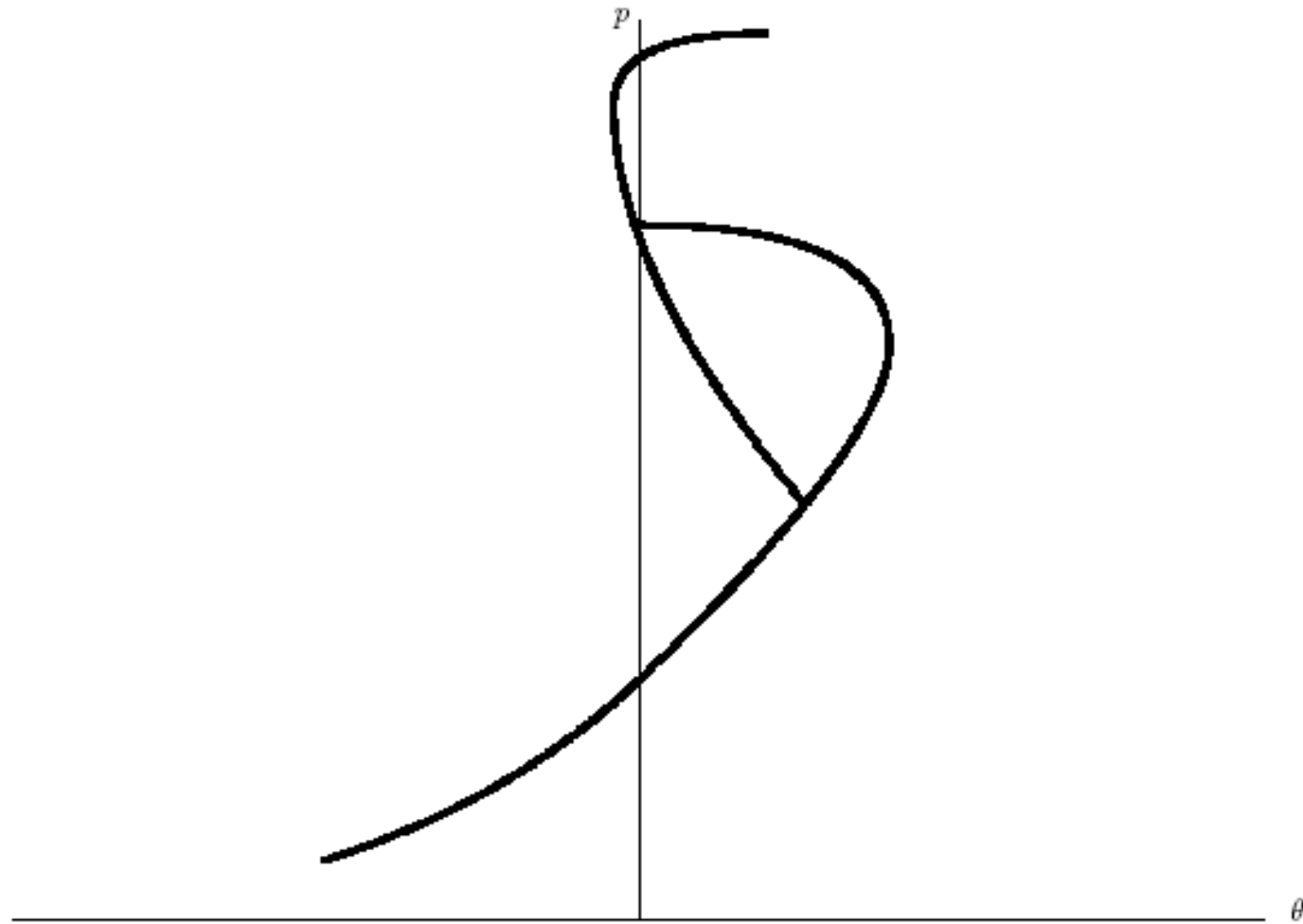

von Neumann Criterion
(Mechanical Equilibrium Criterion)

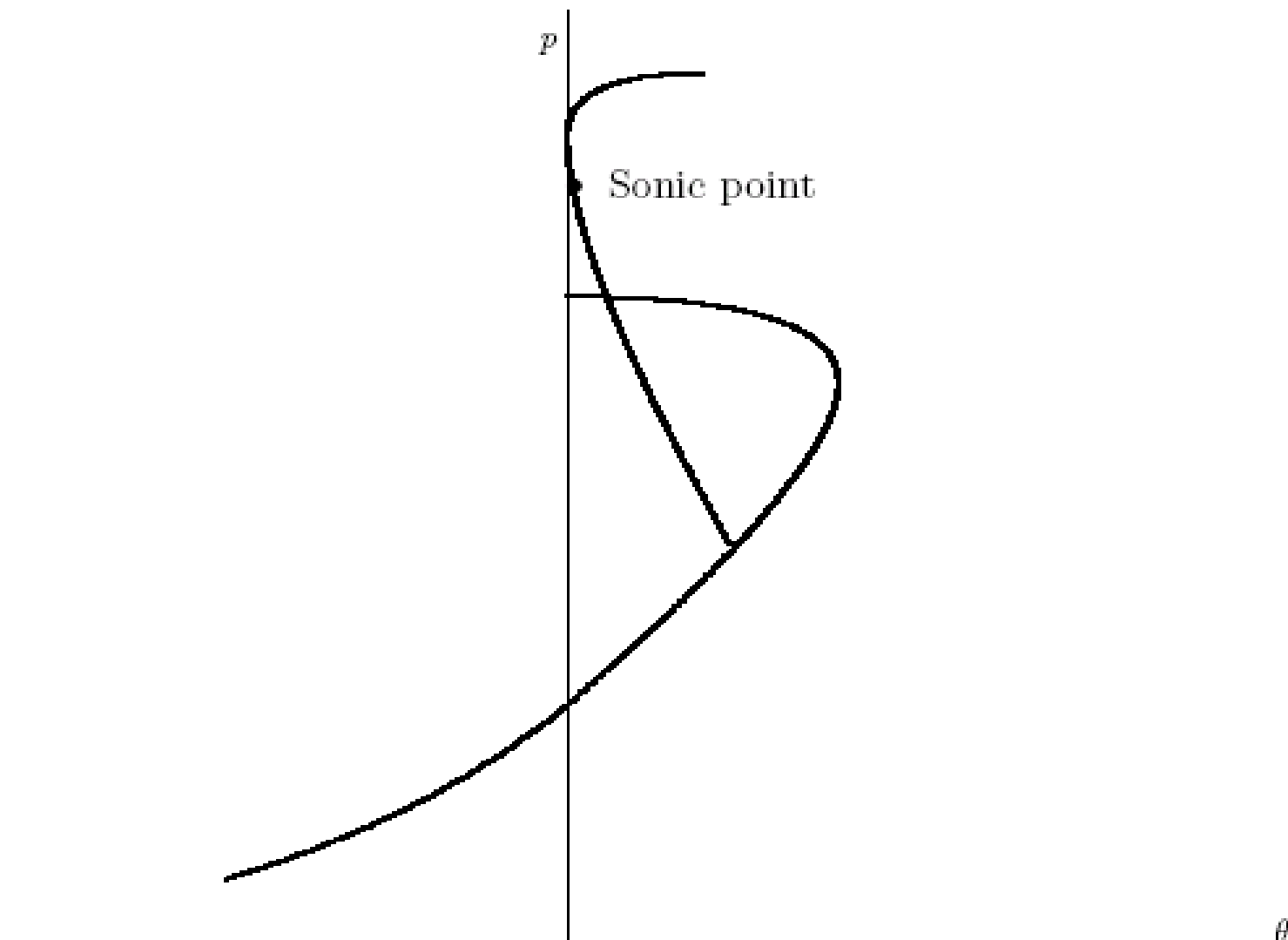

Detachment Criterion

Transition criterion

- von Neumann criterion
(Mechanism equilibrium criterion)
- Detachment criterion
- Sonic criterion
- Hysteresis phenomenon

$$\beta_D > \beta_S > \beta_N \quad (\beta_D \sim \beta_S)$$

Henderson & Lozzi (1979, experiment) support (N)
Hornung & Robison (1982, experiment) support (N)
Teshukov (1989, linear stability) RR is stable in “dual”
H.Li & Ben-Dor (1996) RR is stable in most of “dual”
D. Li (2007, stability on linearized system), support(S)
V.Elling (2008, PDE) Find a solution above β_S

Chpoun (1994) Hysteresis in “dual”

Ben-Dor, Ivanov, Vasilev, Elperin (2002) Hysteresis in
“dual”

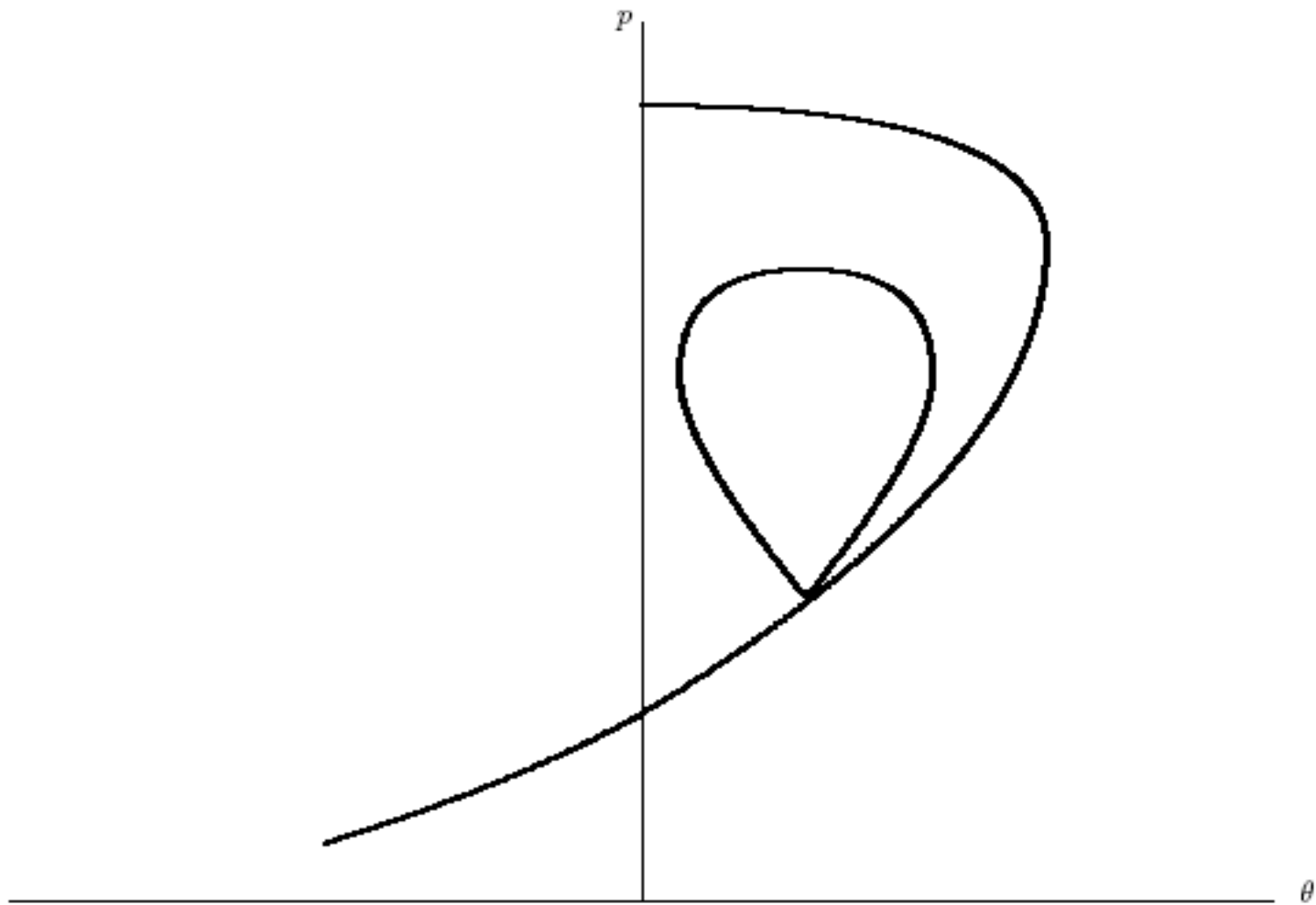

No Mach reflection

(According to von Neumann model)

Von Neumann Paradox

Discrepancies between von Neumann's three shock theory and experiments (first reported by White)

Particularly for weak incident shock

Von Neumann Paradox

If (the incident shock) i is sufficiently weak, von Neumann's model has no physical solution for MR but experiments produce MR-like phenomena. Apparent persistence of RR and MR into regions where von Neumann's model has no realistic predictions was called "the von Neumann paradox" by Birkhoff (1950)

---- Colella, P. & Henderson, L.F.

Problem: Are there other irregular configurations?

- Von Neumann Reflection (NR)
- Guderley Reflection (RR)
- ?R

4 - Wave Theory

E.I. Vasilev, T.Elperin & G.Ben-Dor

Analytical reconsideration of the von Neumann paradox in the reflection of a shock wave over a wedge, Physics of Fluid v.20(2008).

Von Neumann Configuration (suggested by Collela & Henderson)

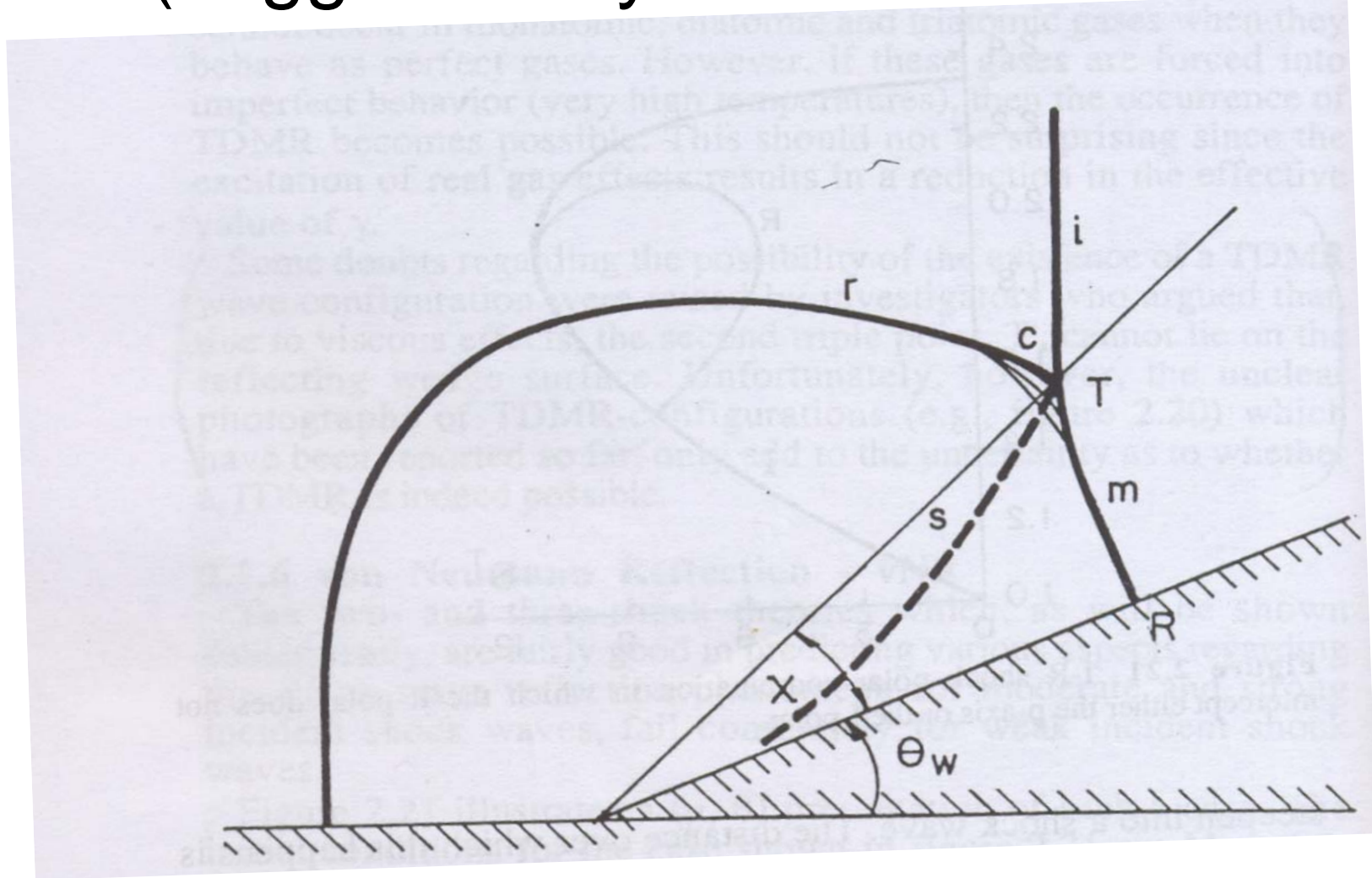

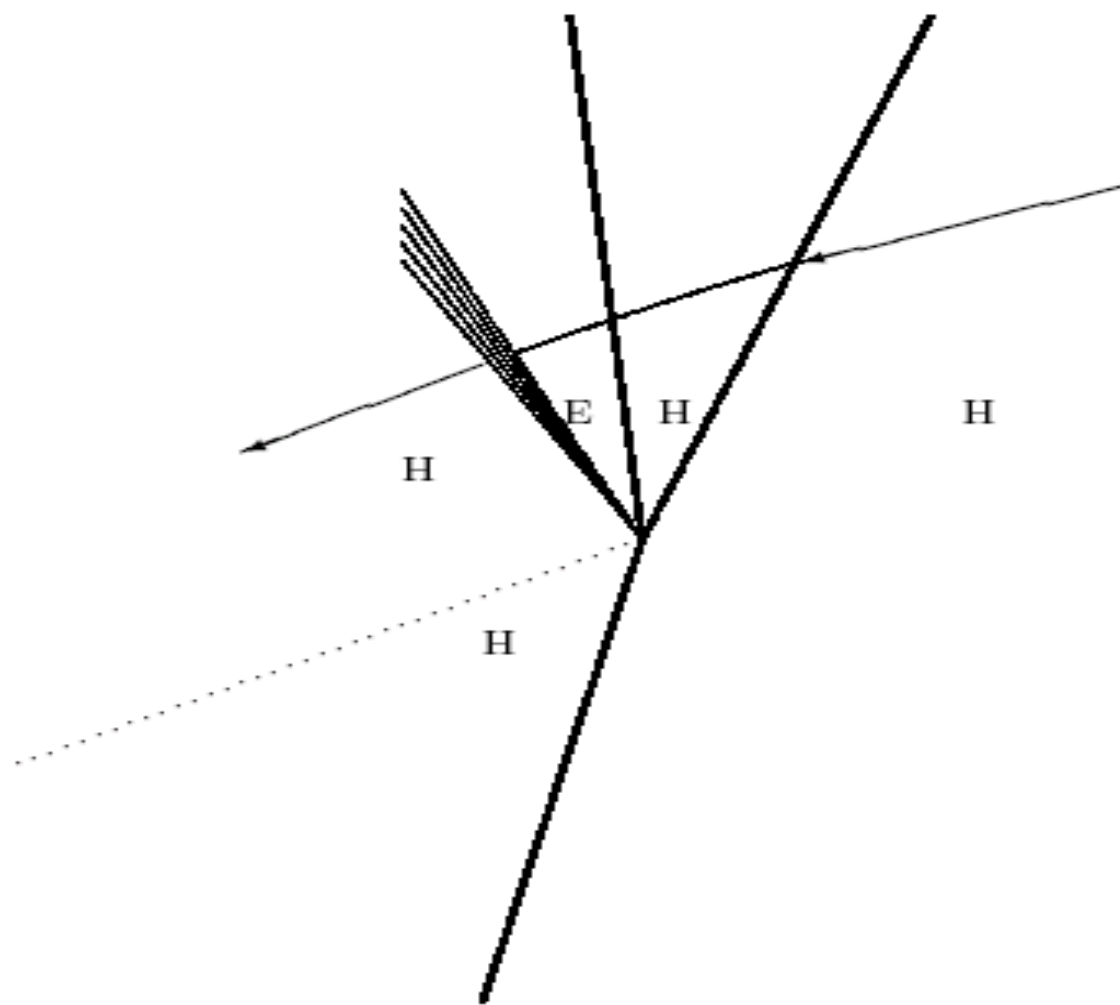

Guderley Reflection

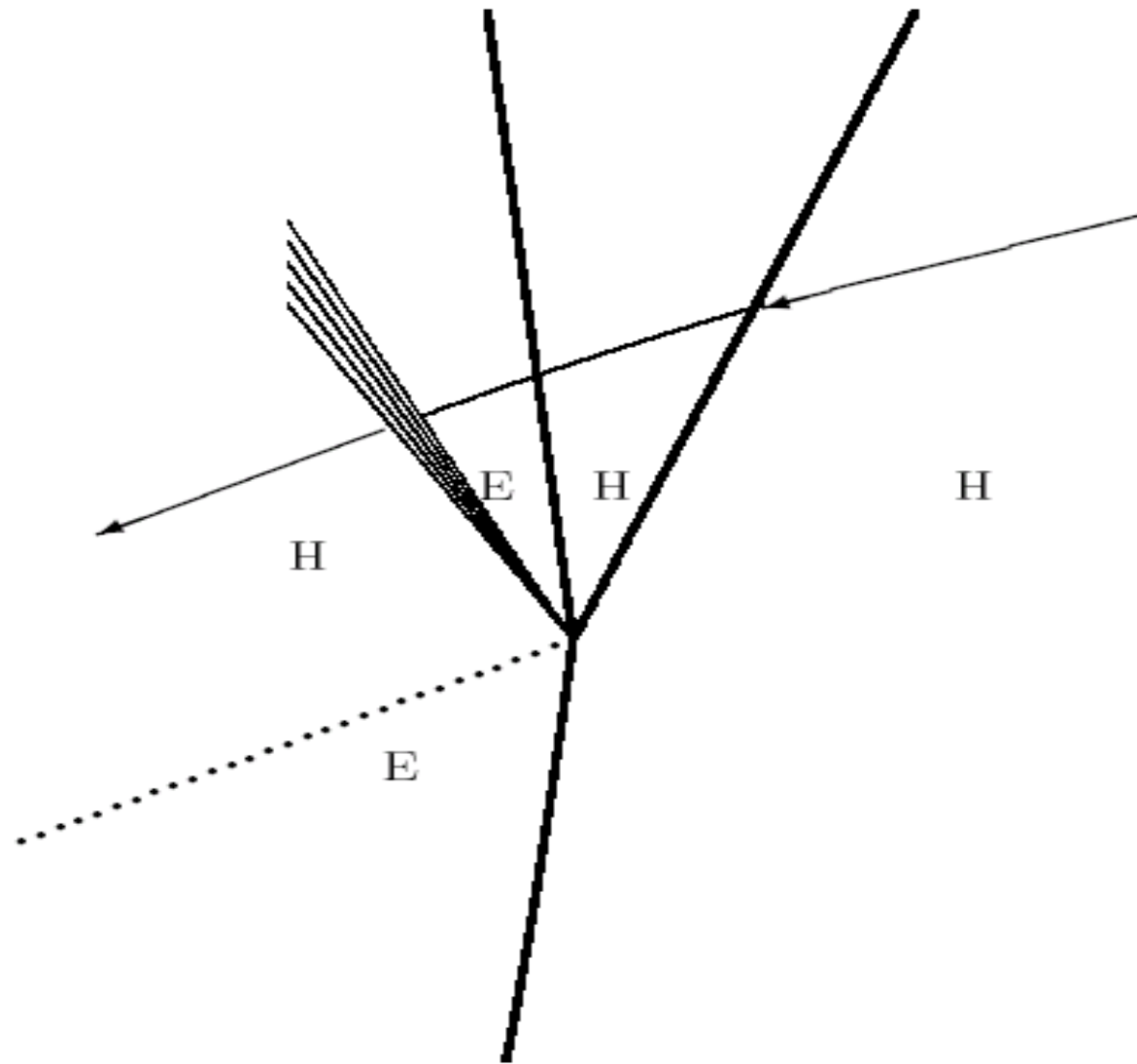

? Reflection

Four wave configuration

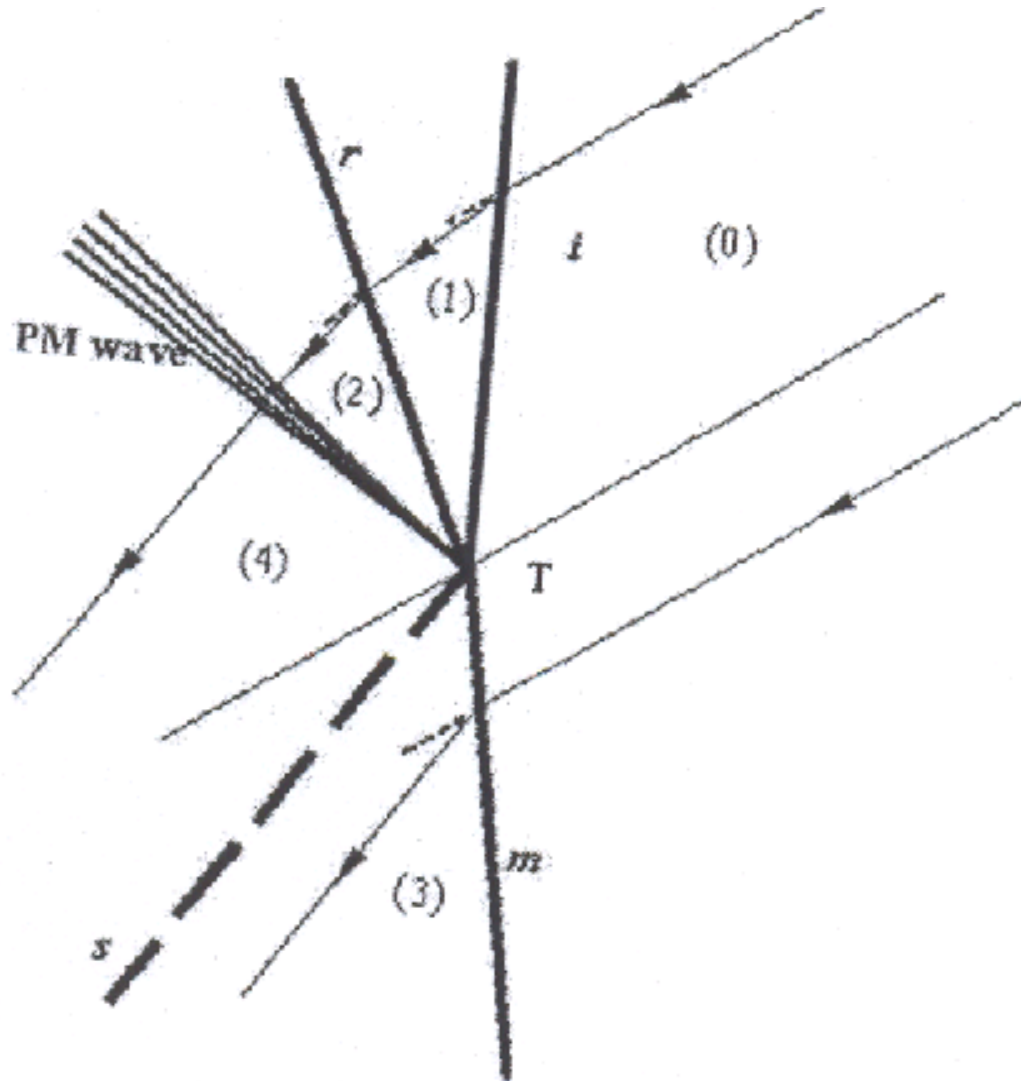

Global wave pattern

(pseudo-steady case)

E-H type Mach
configuration causes more
complicated wave pattern

Global wave pattern ***(pseudo-steady case)***

- Single Mach reflection
- Transition Mach reflection
- Double Mach reflection
- Transitional-double Mach reflection
- Triple Mach reflection

(G. Ben Dor Shock Waves v.15, 2006)

Double Mach Reflection



DMR

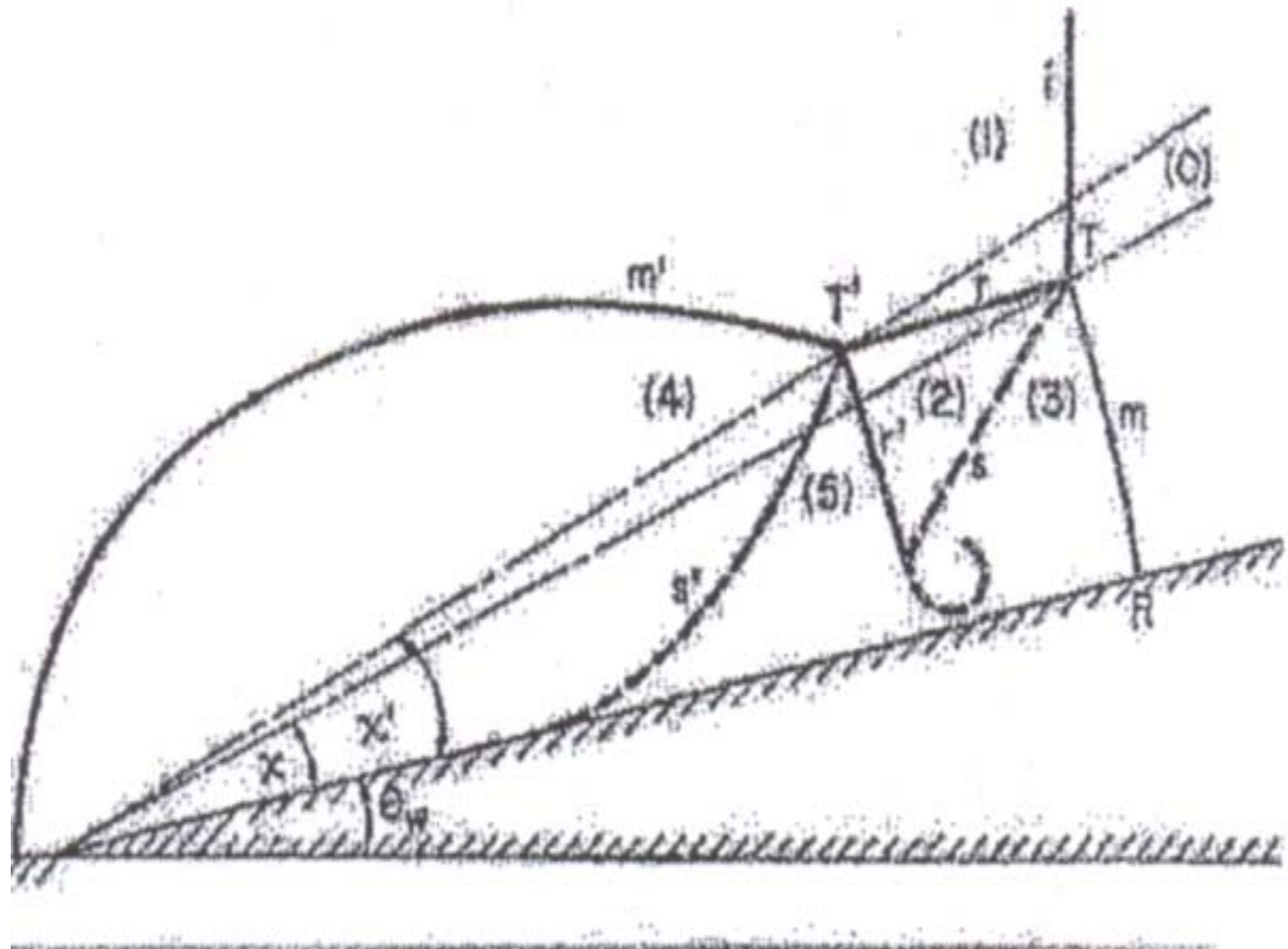

Transition Mach Reflection

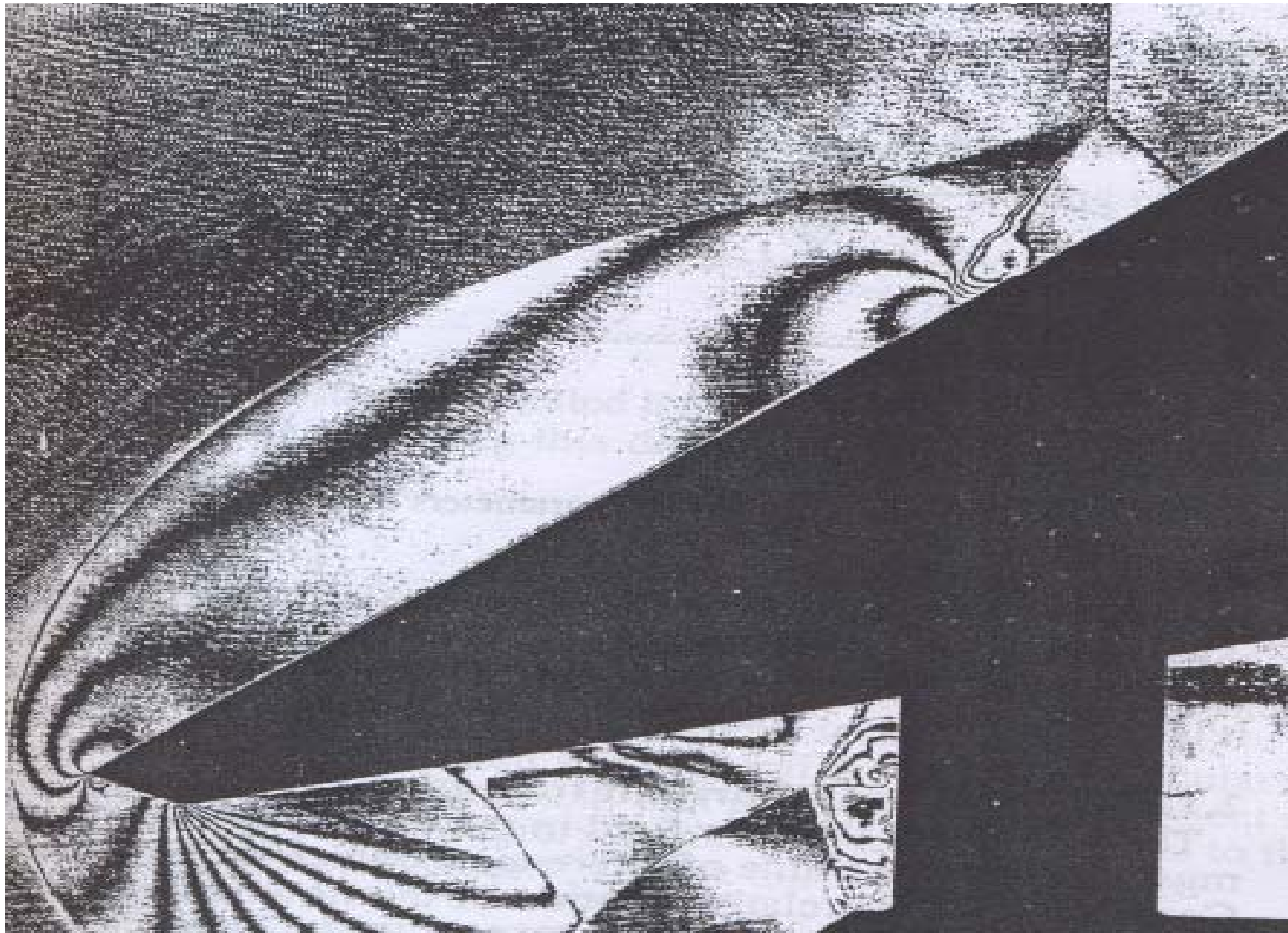

TMR

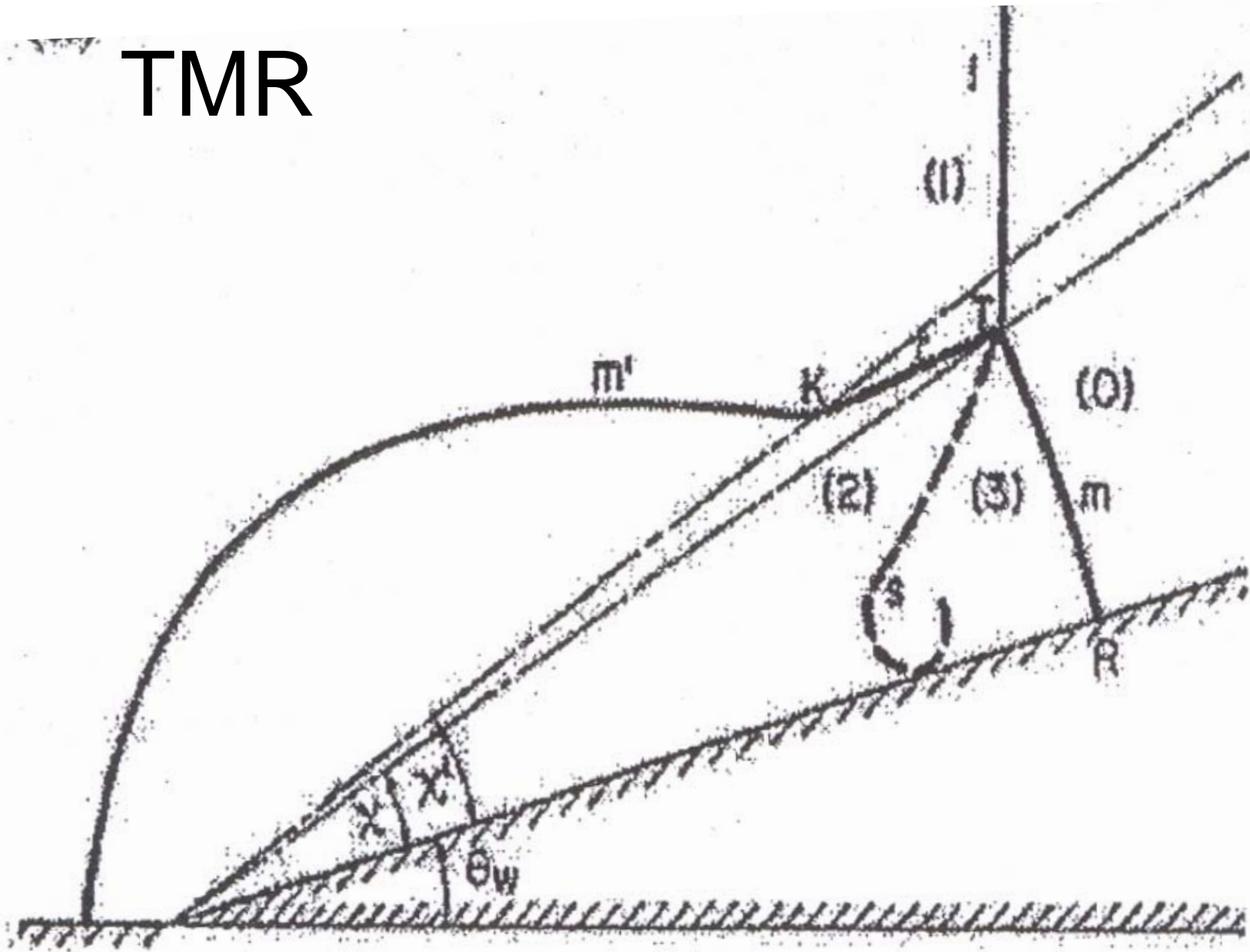

Classification of steady Mach reflection

- Direct Mach reflection
- Stationary Mach reflection
- Inverted Mach reflection

(R.Courant & K.O.Friedrichs)

Direct Mach reflection

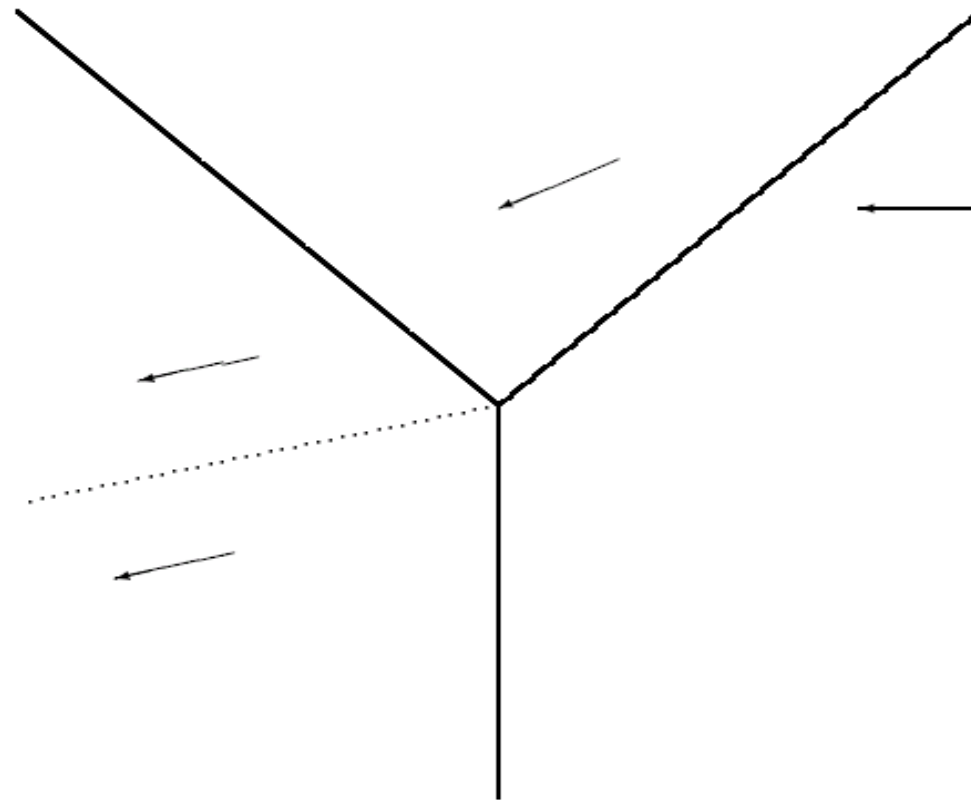

Stationary Mach reflection

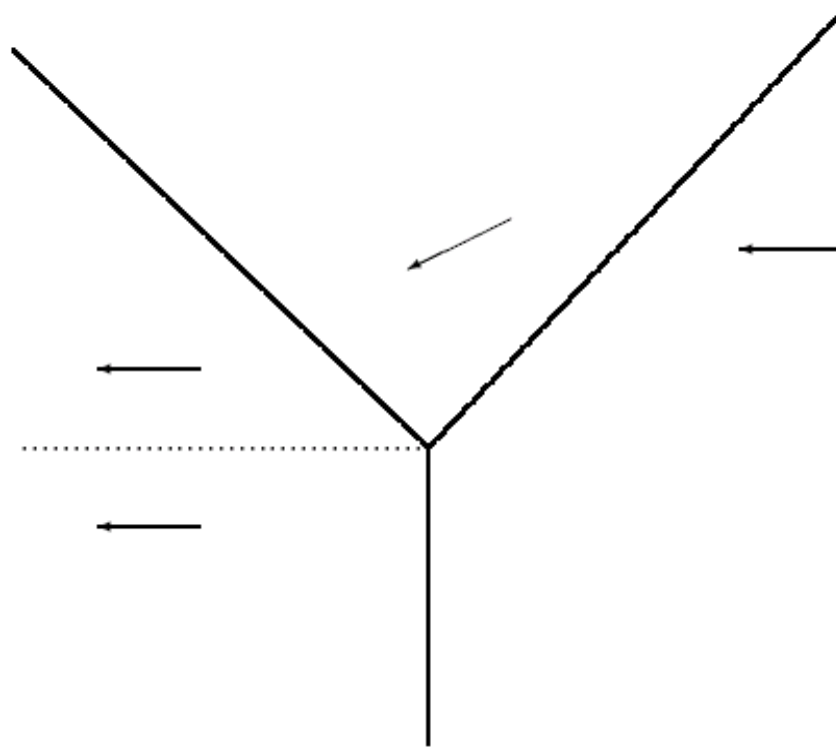

Inverted Mach reflection

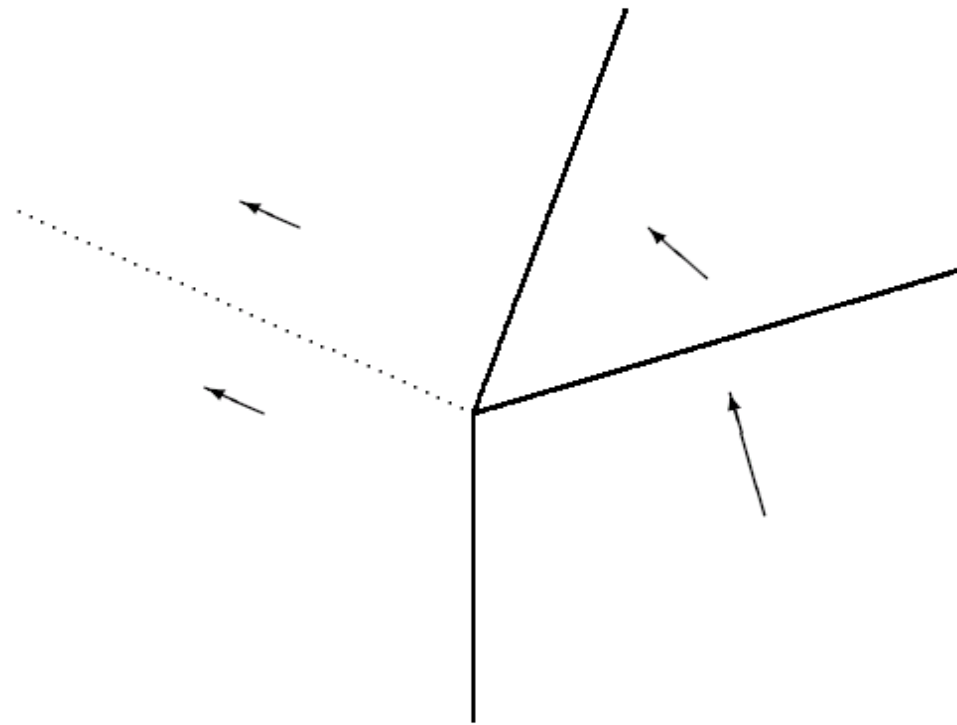

Inverted Mach configuration is unstable

By subtracting the velocity of the upstream flow from all velocity vectors, these configurations are reduced to reflection configurations, moving into quiet gas, then

for inverted Mach conf. the triple point moves towards the wall, so that would be quickly destroyed.

Part III:

Stability of stationary Mach reflection

Perturbed stationary Mach reflection

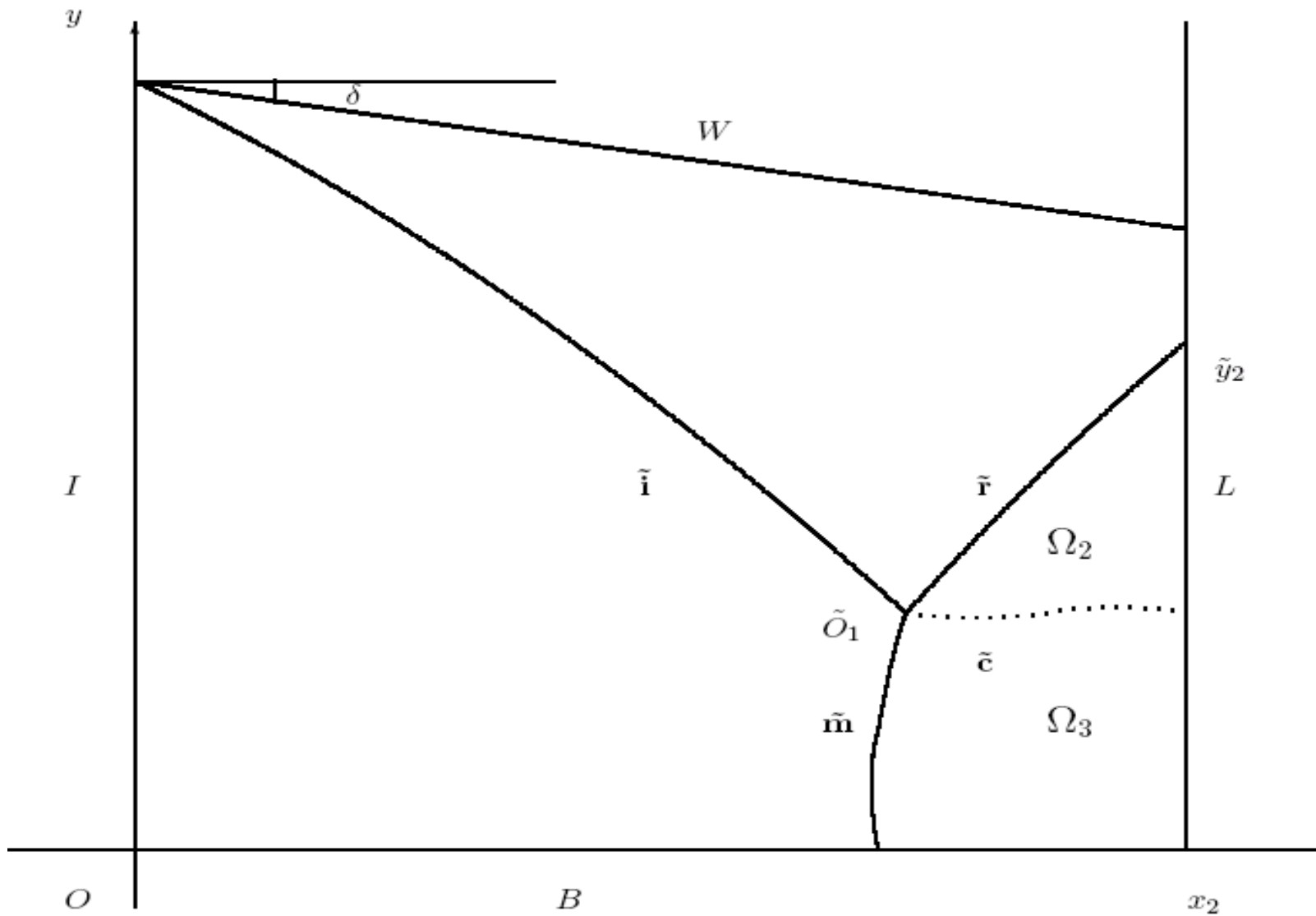

2-D Stationary Euler System

$$\left\{ \begin{array}{l} \frac{\partial(\rho u)}{\partial x} + \frac{\partial(\rho v)}{\partial y} = 0, \\ u \frac{\partial u}{\partial x} + v \frac{\partial u}{\partial y} + \frac{1}{\rho} \frac{\partial p}{\partial x} = 0, \\ u \frac{\partial v}{\partial x} + v \frac{\partial v}{\partial y} + \frac{1}{\rho} \frac{\partial p}{\partial y} = 0. \end{array} \right.$$

Bernoulli Law:

$$\frac{1}{2}(u^2 + v^2) + \frac{a^2}{\gamma - 1} = \text{const.},$$

Rankine-Hugoniot Conditions

$$[\rho u] = \psi'[\rho v]$$

$$[p + \rho u^2] = \psi'[\rho uv]$$

$$[\rho uv] = \psi'[p + \rho v^2]$$

- The main task is to consider the solution in $\Omega_{2,3}$
- Two relations from R-H conditions
- The location of triple point, the shock, the contact are to be determined

Free boundary problem (FB)

System in $\Omega_{2,3}$

Two boundary conditions from R-H

on perturbed shock fronts

p and v/u are continuous

on perturbed contact discontinuity

p is given on L

$v=0$ on B

Approach to some crucial points

- Free triple point (Monotonicity)
- Lagrange transformation to straighten slip line
- Reduce to a fixed boundary value problem
- Decompose the system to elliptic part and hyperbolic part
- Singular integral equation on the “contact”

Free triple point

Take a point (x_{1t}, y_{1t}) on the perturbed incident shock as a temporary fixed triple point. If the problem can be solved, we obtain the intersection

$$(x_2, y_{2t}) = \tilde{r} \cap L$$

The monotonicity of y_{2t} with respect to x_{1t} helps us to find the right location of the triple point.

Lagrange transformation

Define $y=y(x,h)$ by

$$\begin{cases} \frac{dy(x,h)}{dx} = \frac{v}{u}, \\ y(x^*, h) = h \end{cases}$$

The conservation of mass implies

$$\int_{y(x,0)}^{y(x,\eta)} \rho u dy$$

is independent of x . Then the transform

$T: x=\xi, y=y(\xi,\eta)$ can straighten all stream lines, including the slip line.

Fix free boundary

- Form two relations from the R-H conditions on the free boundary, construct a fixed boundary value problem.
- Choose one condition from R-H conditions to update the free boundary.

Decomposition

- The system is elliptic-hyperbolic composite system, which can be decomposed in its principal part.
- The elliptic part can be reduced to a second order equation

Potential theory and singular integral equation on “slip line”

- It is reduced to solve a second order equation with discontinuous coefficients on “slip line”.
- The consistency condition on “slip line” leads to a singular integral equation
- Giraud’s approach to reduce the singular integral equation to a Fredholm equation.

(FB)

- $\Rightarrow (FB)_t$ Fix triple point
- $\Rightarrow (\widehat{FB})$ Lagrange trans.
- $\Rightarrow (NL) + \dots$ Fix free boundary
- $\Rightarrow (L)$ Linearization
- $\Rightarrow (L_1)$ Decompose system
- $\Rightarrow (L_2)$ Reduce to 2-order eq.
- $\Rightarrow (SIE)$ potential theory

singular integral equation

***The solvability of the singular
integral equation implies the
solvability of***

--- Boundary value problem of elliptic
equation of order 2

--- All intermediate boundary value
problems

(Linear system, Nonlinear system,
Free boundary value problems ...)

--- Original physical problem

Conclusion:

Global existence of stationary Mach reflection.

Stability with respect to the upstream data and the downstream pressure:

$$D(\tilde{U}, U) \leq C(D(\tilde{U}_I, U_0^0) + D(\tilde{p}|_L, p^0|_L))$$

Remark

“The global wave pattern”

and

“The height of Mach stem”

strongly depends on the

downstream condition

Open questions for mathematicians

- Confirmation of E-H type Mach configuration
- Choose a correct transition criterion
- Prove or disprove other irregular configuration
- Existence and stability of global wave pattern involving Mach configuration

Thank you